

BEDU
≡ POMPEN ≡

Magnetic Drive Pumps

Centrifugal, Metallic pumps

- CM MAG-M series



User Manual



made for your process

CONTENTS

GENERAL WARNINGS AND SAFETY	4
Symbols used in the manual	4
WARRANTY	4
NAMEPLATE	5
PUMP DESCRIPTION AND OPERATING PRINCIPLE	7
Applications	7
TECHNICAL DATA	7
ALLOWABLE NOZZLE LOADS	8
NOISE AND VIBRATION	11
RADIATION IONISING	11
CHECKS TO PUMP DELIVERY, STORAGE	11
SHIPPING AND HANDLING	11
ASSEMBLY, INSTALLATION, CONNECTIONS, COMMISSIONING AND SETTING	12
Assembly	12
Connection of the pump to suction and discharge pipes	12
Checks for the proper operation	13
Commissioning and operator training	13
Self-priming pumps and non self-priming pumps	14
Coupling of the pump to the motor	14
Features and installation of pump and motor assembly	14
Alignment of the coupling	14
Alignment tolerances and coupling	15
INTENDED USE OF THE PUMP. IMPROPER USE. DESCRIPTION OF FUNCTIONING. PERSONAL PROTECTIVE EQUIPMENT DURING USE	15
Intended use of the pump	15
Instructions for proper use reasonably foreseeable	15
Not permitted use	15
RESIDUAL RISKS AND PROTECTION MEASURES TO BE TAKEN	16
Description of the residual risks that remain	16
Protection measures to be taken by the user and instructions	16
Personal protective equipment to wear	16
OPERATIONAL LIMITS, DESCRIPTION OF HAZARDS NOT EXCLUDED FROM THE SECURITY MEASURES TAKEN	16
Safety information present on the pump	17
INSTRUCTIONS AND PROCEDURES FOR THE TRAINING OF THE PERSONNEL AND FOR EMERGENCIES	17
Recovery mode	17
Fire-fighting equipment to be used:	18
Emission / dispersion of harmful substances	18
MALFUNCTIONING, FAILURE, BREAKDOWN, ACCIDENT. MOST FREQUENT PROBLEMS: CAUSES AND REMEDIES	18
Malfunctioning and Failure	18
Breakdown	18
Accident	18
Most frequent drawbacks: problems, causes, remedies, residual risks	18
PERIODIC AND EXTRAORDINARY MAINTENANCE	21
Cleaning components and magnet	21
Periodic preventive maintenance	21
Emptying of the fluid contained in the pump	22
Draining the oil contained in the pump	22
Extraordinary maintenance	23
REPAIR AND PARTS REPLACEMENT	23
The periodic maintenance specified in the " PERIODIC AND EXTRAORDINARY MAINTENANCE "	23
Pump reassembling	26
DECOMMISSIONING, DISMANTLING AND DISPOSAL OF MATERIALS	26
Decommissioning	26
Demolition and dismantling	27
NOTES	27
APPENDIX A – Register of maintenance and periodic checks of the pump	28

GENERAL WARNINGS AND SAFETY

This manual was prepared by Bedu pump to provide the buyer all necessary informations for its proper use and regular maintenance. In this manual is also contained the manual of the electric motor when the pump is supplied with this.

For safety and hygiene of the workplace and to ensure a fair and sustainable use of the pump, the manual should be kept for any consultation.

As part of the pump, this manual must go with it.

For any given non-deductible or not included in this manual is recommended that you contact Bedu Pompen BV.

Do not use the pump before you have read and assimilated all safety rules and instructions in this manual.

In case of damage or loss of the manual, ask for a copy to Bedu Pompen BV promptly.

The failure to follow instructions in this manual, exempt Bedu from any liability.

The pump and the instructions are intended for operators who make professional use and should be used by qualified personnel adequately trained, aware of uses, operation and risk that the pump generates during its use, the user with experience is the best form of qualification.

Bedu reserves at any time the right to make changes deemed necessary to improve the pump, taking care to update this manual as soon as possible. This reflects the state of the art at the marketing pump. In case of transfer of the pump, the user is encouraged to report to Bedu the address of the new owner to facilitate the transmission of any additions to the manual to the new user. Bedu reserves all rights to this manual, no total or partial reproduction is allowed without written permission.

Symbols used in the manual

In the text to indicate the risk of maneuvers or possible dangerous situations, warnings have been included, each of which consists of a symbol followed by a warning.

MAGNETIC



Persistence of a magnetic field. This field may represent an immediate danger to individuals who have electronic medical devices, metal heart valves, metal or any other metal objects, impairing its functionality.

Bedu declines any responsibility for any damages to people who did not keep a safe distance of at least 1metre, where it is shown that symbol

DANGER



Indicates a potential risk to operators who are using the pump and / or the integrity of the pump, which could result in damaging itself and / or serious injury to people concerned.

CAUTION



Calls attention to important details that the staff must know and keep in mind for the proper use and operation of the pump.

PROHIBITION



Calls attention to transactions that are absolutely prohibited, not respecting the prohibition you may damage the pump and / or operators.

Bedu declines responsibility for damages to things or people for not having complied with the prohibitions set.

WARRANTY

Valid for one year from the date of the pump sale. Bedu do not assume any liability for any warranties explicit or implied, nor as regards the possibility to sell or the suitability of the items supplied.

The warranty will not be applied if:

- the repair and / or maintenance was not carried out strictly in accordance with the instructions;
- the pump has not been installed and put into service as instructed;
- the repairs were not made by staff Bedu or were made without consulting Bedu;
- spare parts are not original were used;
- lubricants were used different from those recommended;
- the parts supplied were not used according to their nature and / or destination;
- the parts supplied were used carelessly, negligently, improperly;
- the parts supplied were damaged due to external circumstances.

All wear parts are excluded from warranty.

NAMEPLATE

The pump for installation in ordinary environments has the nameplate on the side of the support as shown: only the fields are compiled must be considered relevant and therefore valid for identification.



The serial number of the pump, here called serial number (s.nr) defines the type of components installed in the pump:

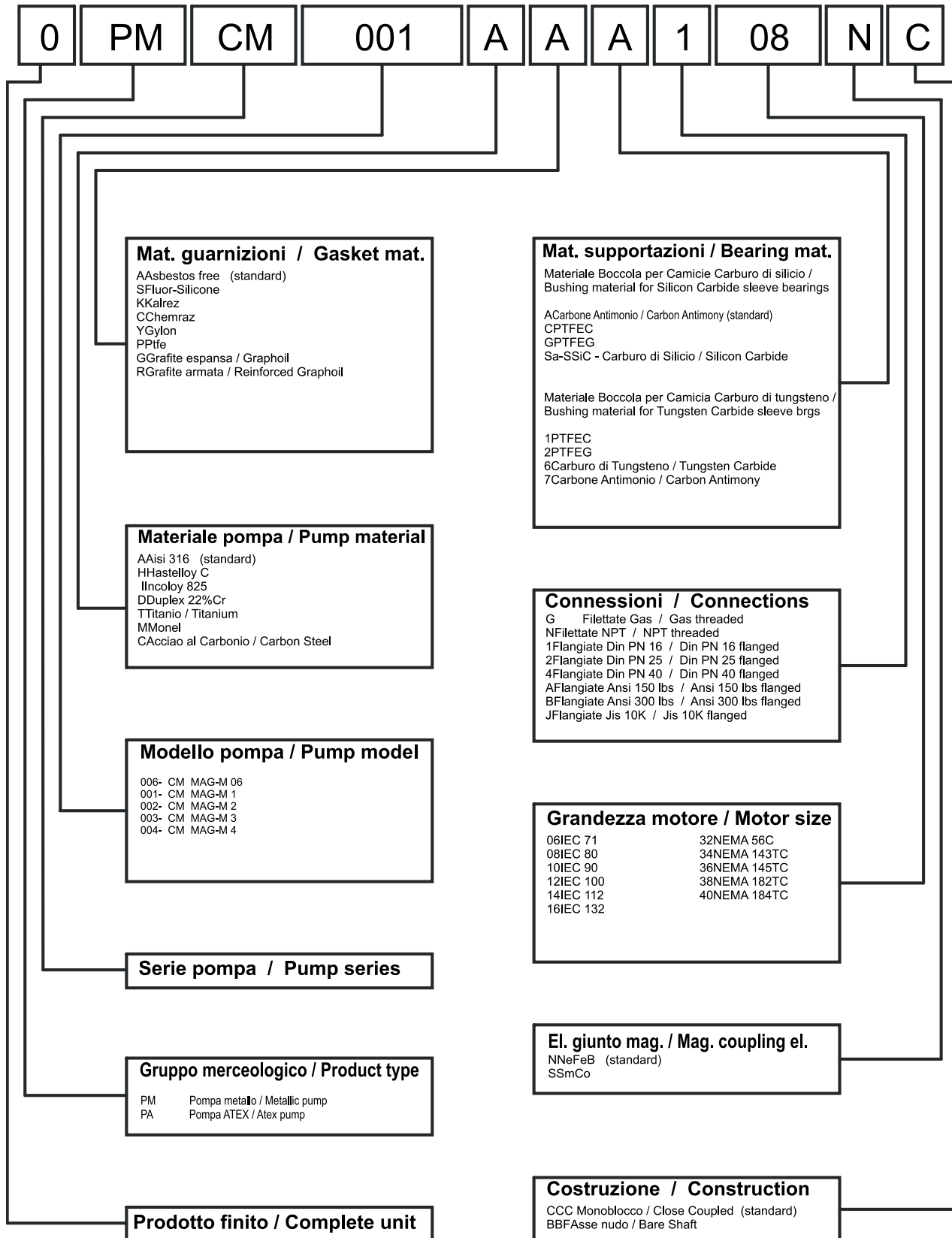

This configuration for complete unit only

PUMP DESCRIPTION AND OPERATING PRINCIPLE

Key feature of magnetic drive pumps is that the fluid that has to be pumped never comes into direct contact with engine parts, ensuring the physical separation between the motor and the pump and the transmission is delivered via a coaxial magnetic coupling.

The pump consists of a part (outer rotor) that is coupled to an electric motor through elastic coupling (bare shaft version) or directly (close coupled) and a part (internal rotor integral with the pump impeller) that allows fluid pumping. The outer rotor consists of a series of magnetic elements with variable features and size suitable to the torque to be transmitted. The inner and outer rotor magnets are a magnetic circuit, characterized by overlooked opposite polarity pairs. At electric motor start, the outer rotor, when rotating, drives synchronously the internal rotor, thus the power is transmitted to the pump impeller that explains the liquid pumping contained in the pump body. A static containment shell, called rear casing, located between the two rotors, separates the liquid from the atmosphere, making the pump hermetic.

Applications

– Generally this model is ideal for clean liquids slightly contaminated, without particles that can be magnetized;
– The maximum working pressure of the plant, the allowable temperature and the maximum rotation speed depends on the type of pump and it is specified in the "TECHNICAL DATA" paragraph. Other uses are not allowed as the conditions of use stated in the "TECHNICAL DATA" paragraph must be respected in full. Using the pump in a plant or in liquid conditions different from those for which the pump was designed, can lead to dangerous situations to the user.

TECHNICAL DATA

The pumps described in this manual have the following characteristics:

Available in bare shaft configuration or close couple, with the engine directly keyed to the pump support.

CM MAG-M

- Nozzle: DIN PN16 / PN40, ANSI B 16.5 150lbs flanged or BSP / NPT Threaded;
- Max viscosity: 200 cSt;
- Max system pressure: 25 BAR (standard)
 50 BAR (HP version)
 ___ BAR (special version on request)
- Flow up to 35 mc/h;
- Head up to 36 m;
- Working temperature up to +250 °C (std. Version), to 300°C for special version
- Installable motor power: from 0,25KW to 11KW;
- Speed: up to 3500 rpm;
- Weight (pump only): from 1,7 to 45 kg;

Electric Motor characteristics:	Supply frequency: 50 Hz	Supply frequency: 60 Hz
2 poles	2900 rpm	3500 rpm
4 poles	1450 rpm	1750 rpm

CAUTION



– CAUTION: If the pump is driven by inverter, remain within the recommended limits of rotation

ALLOWABLE NOZZLE LOADS

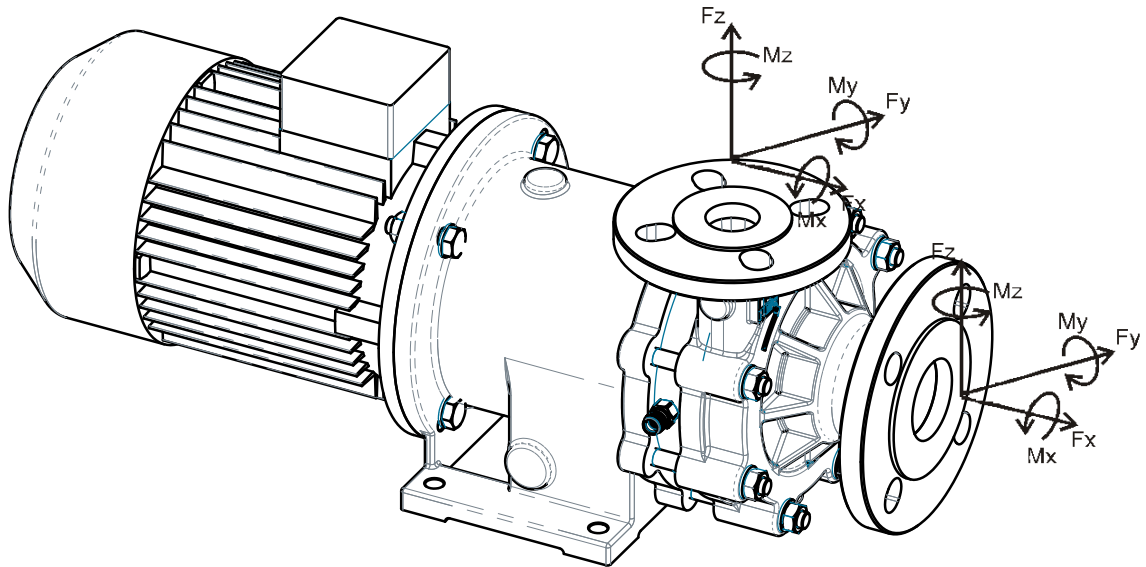

PUMP SIZE	FORCES [N]								MOMENTS [Nm]							
	Fx		Fy		Fz		Fr		Mx		My		Mz		Mr	
	IN	OUT	IN	OUT	IN	OUT	IN	OUT	IN	OUT	IN	OUT	IN	OUT	IN	OUT
06	340	300	300	280	280	340	520	520	360	360	240	240	280	280	520	520
1	500	300	440	280	400	340	780	520	520	360	360	240	420	280	760	520
2	660	360	600	340	540	420	1040	660	560	440	400	300	460	340	820	640
3	660	440	600	400	540	500	1040	780	560	520	400	360	460	420	820	760
4	840	600	740	540	680	660	1320	1040	600	560	440	400	480	460	880	820

LOADS TO BE CONSIDERED VALID ONLY FOR VERSION FLANGED

Operating limits and performances
CM MAG-M

Curve N°: 10452	1450 RPM
-----------------	----------

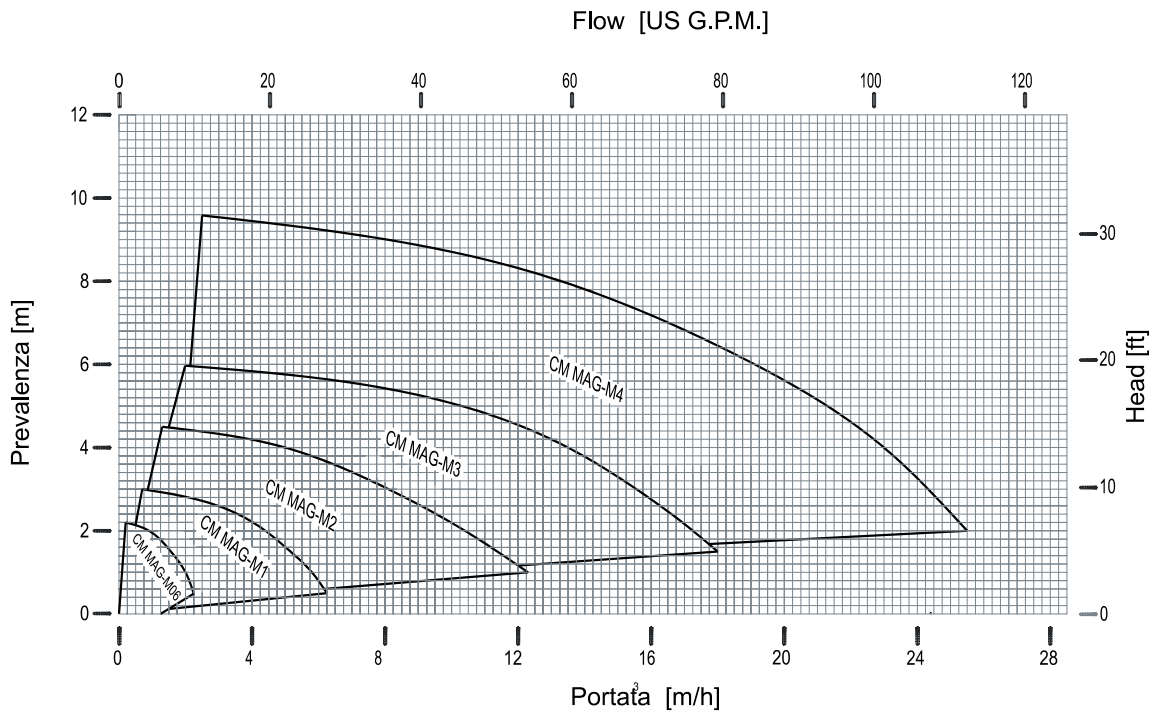

Curve N°: 10452	2900 RPM
-----------------	----------

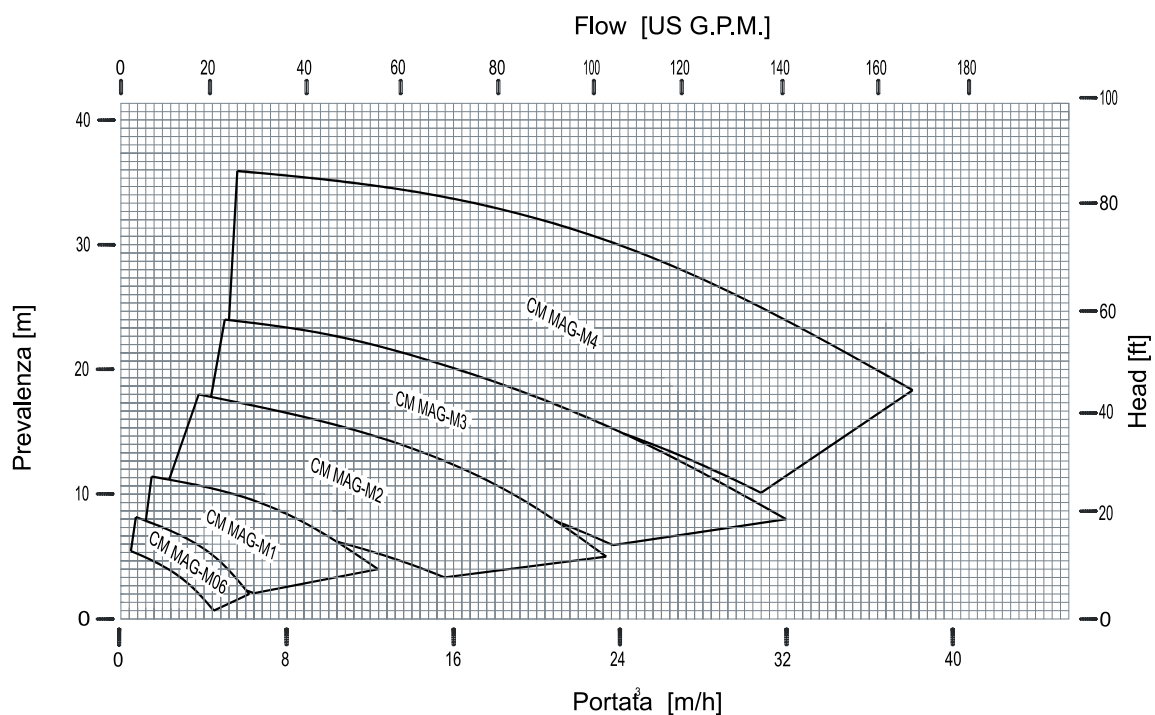

OVERALL DIMENSION

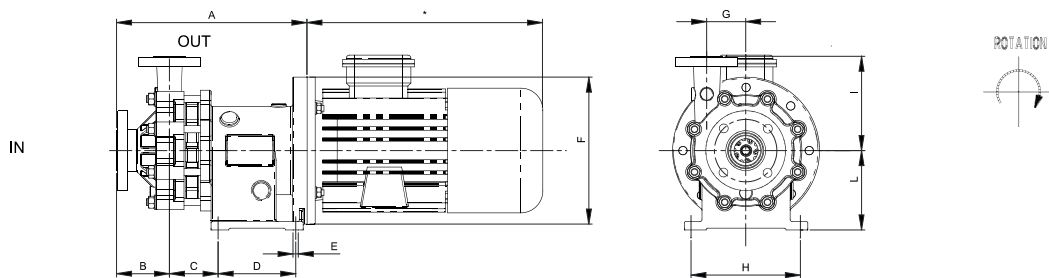

ASPIRAZIONE		SUCTION			
flangiato UNI 2282-67 PN.16		flanged UNI 2282-67 PN.16			
Nome Pompa Pump Name	p	q	r	s	
CM MAG-M 1	40	110	150	18	
CM MAG-M 2	50	125	165	18	
CM MAG-M 3	50	125	165	18	
CM MAG-M 4	65	145	185	19	

MANDATA		DISCHARGE			
flangiato UNI 2282-67 PN.16		flanged UNI 2282-67 PN.16			
Nome Pompa Pump Name	p	q	r	s	
CM MAG-M 1	25	85	115	14	
CM MAG-M 2	32	100	140	18	
CM MAG-M 3	40	110	150	18	
CM MAG-M 4	50	125	165	18	

ASPIRAZIONE		SUCTION			
flangiato ANSI B,16,5 150 lb/sq. in.		flanged ANSI B,16,5 150 lb/sq. in.			
Nome Pompa Pump Name	p	q	r	s	
CM MAG-M 1	40,9	98,4	127	16	
CM MAG-M 2	52,6	120,6	152,5	19	
CM MAG-M 3	50,6	120,6	152,5	19	
CM MAG-M 4	65	152,4	190,5	19	

MANDATA		DISCHARGE			
flangiato ANSI B,16,5 150 lb/sq. in.		flanged ANSI B,16,5 150 lb/sq. in.			
Nome Pompa Pump Name	p	q	r	s	
CM MAG-M 1	26,7	79,4	108	14	
CM MAG-M 2	35,1	88,9	117,5	16	
CM MAG-M 3	40,9	98,4	127	16	
CM MAG-M 4	50	120,6	152,4	19	

ASPIRAZIONE		SUCTION			
flangiato ANSI B,16,5 300 lb/sq. in.		flanged ANSI B,16,5 300 lb/sq. in.			
Nome Pompa Pump Name	p	q	r	s	
CM MAG-M 1	40,9	114,3	155,6	22,4	
CM MAG-M 2	52,6	127	165,1	19 (19/16mm)	
CM MAG-M 3	52,6	127	165,1	19 (19/16mm)	
CM MAG-M 4	65	168,3	209,5	22,4 (22/16mm)	

MANDATA		DISCHARGE			
flangiato ANSI B,16,5 300 lb/sq. in.		flanged ANSI B,16,5 300 lb/sq. in.			
Nome Pompa Pump Name	p	q	r	s	
CM MAG-M 1	26,7	88,9	123,8	19	
CM MAG-M 2	2"	27	72	45	
CM MAG-M 3	40,9	114,3	155,6	22,4	
CM MAG-M 4	50	127	165,1	19 (19/16mm)	

Nome Pompa Pump Name	Gr. motore Motor Size	A	B	C	D	E	F	G	H	I	L
CM MAG-M 1	80	275	89	61	105	11	200	44	165	105	85
CM MAG-M 2	90	305	100	74.5	109	11	200	62	180	130	103
CM MAG-M 3	100/112	340	106	78	120	11	250	66	180	147	135
CM MAG-M 4	132	357.5	86	94	151.5	14	300	80	215	170	155

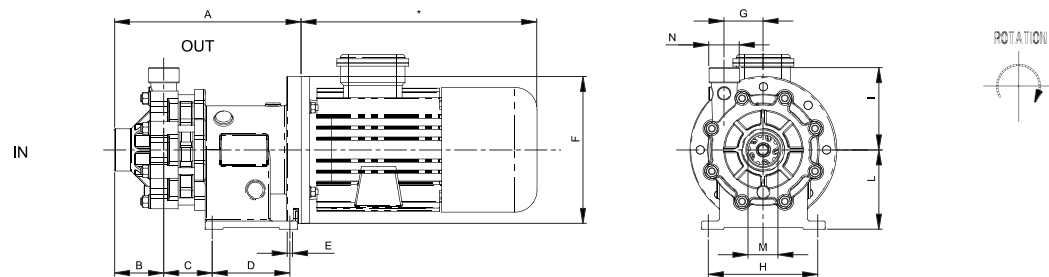

ASPIRAZIONE		SUCTION			
Connessioni filettate BSP-F UNI ISO 228/1 o NPT-F USAS B2-1/1988		Port connection BSP-F UNI ISO 228/1 or NPT-F USAS B2-1/1988 threaded			
Nome Pompa Pump Name	p	q	r	s	
CM MAG-M 06	1"	18,5	45	32	

MANDATA		DISCHARGE			
Connessioni filettate BSP-F UNI ISO 228/1 o NPT-F USAS B2-1/1988		Port connection BSP-F UNI ISO 228/1 or NPT-F USAS B2-1/1988 threaded			
Nome Pompa Pump Name	p	q	r	s	
CM MAG-M 06	1"	18	28	18	

Nome Pompa Pump Name	Gr. motore Motor Size	A	B	C	D	E	F	G	H	I	L
CM MAG-M 06	71	212.5	56.3	60	80	9	160	46	140	90	84

OVERALL DIMENSIONS

See specific documentation provided with this manual.

NOISE AND VIBRATION

The pump noise depends primarily on the operating conditions. The operating condition of the pump during the measurements is: the coupling of the pump with the electric motor on the bench with pumping fluids.

The A-weighted sound pressure level to front and side of the pump is below 85 dB (A).

RADIATION IONISING

The pump does not emit any kind of ionising radiation that could endanger persons.

CHECKS TO PUMP DELIVERY, STORAGE

All Bedu pumps are tested before shipment and carefully packed for transport: at the reception of the pump make sure that the pump has not been damaged during the transport. If there are problems, contact immediately the carrier and inform Bedu about what happened.

So that the pump is preserved over time as best as possible, we recommend storing it away from the sun, bad weather and dust, if not immediately installed or used for long periods.

Stoppers closing the input and output connections of the fluid must not be removed until installation. If provided with electric motor, observe also the motor manufacturer's storage formality.

The maximum allowable temperature range during storage, preservation and use must be between -15 e +40 °C with humidity between 10 e 90%.

SHIPPING AND HANDLING

You should carry out a precautionary check of the pump at the receiving to detect and report any damage in the transport and handling operations. In case of breakages contact immediately Bedu.

The precautions to ensure the stability of the pump concern the possible slips and overturning caused by handling and transport, which must be prevented by setting the pump casing of the pump with ropes to the vehicle frame.

Pump and motor assembly cannot be moved manually due to its high weight.

To move a pump positioned on a pallet, enlarge as maximum as possible the forks and then operate.

For a stable lifting the pump can be lift as indicated in the figures:

close couple pump without motor

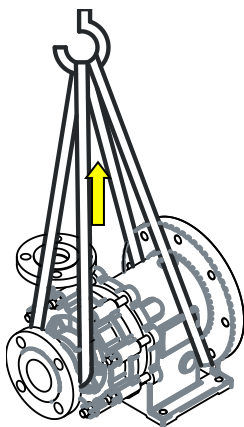

Centre of gravity approximately in the middle

close couple pump with motor

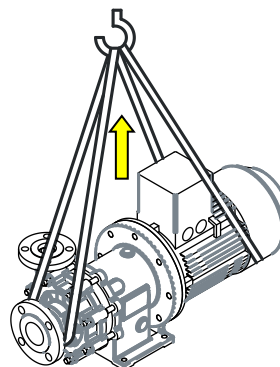

Centre of gravity approximately in the middle

These operations must be performed by a trained staff who is informed of the risk of these proceedings.

PROHIBITION



- It is forbidden to lift the pump using different lugs from the ones specially designed and reported, as points of anchorage.
- You cannot lift a pump and motor assembly using the eye-bolt of the electric motor only.
- During the lifting the entire surrounding area is considered as a danger zone and must be cleared by personnel not engaged in those operations.

It is indicated the possibility of transporting and handling the pump using the lugs designed for that use: you must ensure that chains and shackles are able to withstand the weight of the pump (as shown in "TECHNICAL DATA").

ASSEMBLY, INSTALLATION, CONNECTIONS, COMMISSIONING AND SETTING

Assembly

Install the pump on a solid foundation as close as possible to the liquid to be pumped, below the level, in a position to facilitate maintenance and inspection.

Ensure that the pump doesn't take rough shacks as this may damage the magnets of the internal and external rotor or the silicon carbide bearings.

Ensure that the heated air from other units does not affect the pump; the air temperature must not exceed 40 °C, for higher temperatures contact your distributor Bedu; ensure also the free circulation of air cooling of at least ¼ the engine diameter, because either the pump or the motor should be able to dissipate the heat by natural air convection. Insufficient cooling could lead to high surface temperatures of the bearings seat, poor lubrication and premature failure of bearings. Useful is the monitoring of the surface bearings' temperature.

It is always responsibility of the operator to keep low the temperature of the liquid so that not to superheat the pump: in case of irregular pressure fluctuations and flow drop turn off the pump.

CAUTION



- Normally you should mount the pump horizontally. If mounted vertically or inclined, the pump, or rather the suction flange shall be placed in the lowest point. Leave a space of at least 50 cm between the pump and any walls or pipes.
- When pumping liquid can reach high temperatures: from 60 °C upwards you must install protections to prevent contact with hot pump parts;
- Connect to the ground the entire pump casing to prevent accumulation of static electricity;
- If the pumped liquid can be dangerous to people and environment, the user must take precautions for a simple and quick block in case of leakage for breakage/ replacement/ pump maintenance.

Connection of the pump to suction and discharge pipes

For a proper assembly aimed at an optimal use of the pump, you must follow these requirements:

- pipes must be supported and kept in line regardless of the pump, until its connections, so that not to impose on it;
- links must not be subjected to stresses during the job ;
- the maximum permissible forces and moments on flanges shall not exceed those listed in "technical data";
- inlet pipes should be constructed with as few restrictions as possible in order to have the highest available NPSH;
- the length of pipes , particularly that of the inlet pipe must be minimized;
- the pipe must be placed so that it is not possible the formation of air; if this is not possible, it should be calculated the possibility of bleeding the air from the highest point ;
- during suction use full section valves only;

if the suction tube was larger than the suction flange, you will use an eccentric reduction, in order to prevent formation of air and turbulence;

if there is a possibility that the maximum working pressure can be overcome, for example due to excessive suction pressure, you should take appropriate measures by including a safety valve in the pipe;
Avoid using quick-closing valves, because sudden changes of pressure cause water hammer very dangerous for the pump and the pipes;
Before installing the pump, make sure the suction line is clean and/or provided with a filter to protect the impeller and the stationary bearings from damages incurred by slag, or other foreign particles, especially when you start the installation for the first time.

Electrical connections:

DANGER



The pump is **provided with or without electric motor: only qualified personnel** should carry out mechanical connection of the pump to the motor (for the model without motor) and the electrical connections of the motor to the electrical system. Please read carefully the instructions of the manufacturer of the motor or the manual before you complete the installation.

Make sure that the motor doesn't start during maintenance jobs.

Checks for the proper operation

We recommend installing a pressure gauge on both inlet and outlet pipes to allow the operator to easily control the proper pump functioning in relation to the required operating point: in case of cavitation or other malfunctions, there will be obvious pressure fluctuations.
Check the differential pressure of the pump between the suction and discharge connections to verify that it works in the point of work provided.
Check that the absolute pressure at suction is not so low to cause the cavitation.

CAUTION



The absolute pressure at pump suction (m) must be at least 0,5 to 1 m, the vapour pressure of the pumped liquid, in order to avoid cavitation.
Cavitation should always be avoided as it is very dangerous for the structure of the pump.
Do not dry run the pump!

Commissioning and operator training

- Fully open the inlet valve and fill the pump and suction line;
- Ensure there are no obstacles to the free rotation of the pump impeller.

The Bedu series CM MAG-M **are not reversible** so the rotation cannot be reversed.

The proper direction is **clockwise**.

If you put in front of the pump casing, an arrow indicates the correct direction of rotation; to reverse the direction of rotation may cause damages to the pump.

To control the direction of rotation, give and immediately remove voltage, then observe the direction of rotation.

ROTATION SENSE:

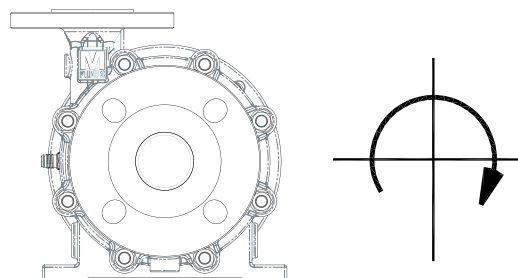

Make sure that rotating parts, such as flexible coupling or other related organs, are always protected when the pump is running.

Operators using the pump must have read this manual in the sections committed to the functioning, use and maintenance, as well as being qualified to fully understand the features and to be able to identify the problems of the pump.

By carrying out the functions mentioned in the previous section and all controls listed in the register maintenance, the pump is ready for use.

Self-priming pumps and non self-priming pumps

CM MAG-M pumps are non self-priming: Make sure the pump is always filled with the pumping liquid to maintain the self-priming feature. Use a back flow check valve to stop reverse flow when operating with suction lift, dry run should be avoided.

Coupling of the pump to the motor

If the pump and the motor are coupled respect the following sequences to proceed with the installation:

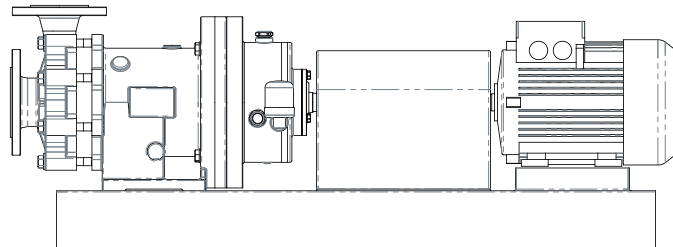

Fill the two elastic coupling halves on the pump and the motor.

Position the pump on the base plate.

Place the motor, insert thicknesses (about 5mm), under the feet, so that the two shafts (pump and motor) are coaxial.

Leave a space of 3mm between the two elastic coupling halves, and then block the motor with the provided screws.

Features and installation of pump and motor assembly

The shafts of the pump and the motor have already been adjusted and aligned as an extension of one another. For installation of the plant it is necessary to respect the sequence of actions:

- The base plate must be affixed to an horizontal plane, using also thickness;
- Tighten the nuts of the bolts;
- Check the shafts alignment and the motor alignment and repeat these actions if necessary (described in the paragraph "Alignment of the coupling").

Alignment of the coupling

- Place a straight edge on the coupling. Insert or remove any thickness necessary to bring the motor at the correct height, so that the bottom edge of the ruler is placed on both halves of the coupling for the entire length;
- Repeat the same check on both sides of the coupling, at the height of the shaft. Turn the motor shaft so that the bottom edge of the straight edge touches both halves of the coupling for the entire length;
- Reinstall the protection.

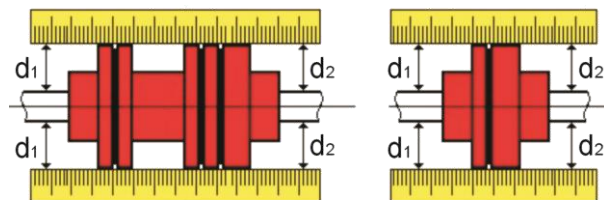

Alignment tolerances and coupling

The maximum allowed tolerances for the two halves alignment of the coupling, to be verified with the comparator, are:

TYPE OF COUPLING	OFFSET	ANGLE
Short flexible coupling (3000 rpm)	0.05mm	0.04mm for coupling with diameter 100mm.
Flexible coupling with spacer (3000 rpm)	0.07mm for spacer 100mm.	0.04mm for coupling with diameter 100mm.

INTENDED USE OF THE PUMP. IMPROPER USE. DESCRIPTION OF FUNCTIONING. PERSONAL PROTECTIVE EQUIPMENT DURING USE.

Intended use of the pump

The magnetic drive pump, thanks to its decoupling between the pump and the motor, never enters into direct contact with motor parts, providing a friction effect on the impeller of the pump. The pump works correctly if the parameters specified in the paragraph "TECHNICAL DATA" are followed.

Instructions for proper use reasonably foreseeable

Before starting work you must check that:

- All maintenance actions were properly carried out according to the time intervals set by Bedu;
- There are no damaged parts of the pump;
- All the warning stickers and safety licence plates are present and in good condition and are operating the emergency stop buttons (check through a test).

CAUTION



Do not dry run the pump!

At the start, immediately check the pressure gauge placed in the discharge: if the discharge pressure reaches the nominal value quickly, stop the pump and try starting. Check the pump and piping to make sure that there is no leakage of liquid from the plant. A noisy pump is a symptom of a malfunction that represent a failure in the short term. A very low frequency and with a rumbling can indicate the state of cavitation; an excessive noise of the motor can be caused by a wear of a bearing.

Not permitted use

While maintaining the conditions of use indicated in the paragraph "TECHNICAL DATA", the ways in which the pump should not be used are given here. To avoid damaging the pump, it is forbidden to use it in the following conditions:

PROHIBITION



- Start the pump dry: the pump casing must be full of liquid.
- Run the pump dry for more than 1 minute;
- Make the pump work with inlet valve and /or outlet closed: the heat generated by the impeller, by magnetic coupling and bearings will boil the liquid, which will cause pump cavitation/vibration, the impeller damaging and the bearings collapse;
- The pump flow should never be adjusted by the valve located in the suction pipe, which must be kept fully open, start and or make the pump work if there are losses;
- Start the pump if there are losses;
- Change working condition of the pump without having consulted the Bedu

- technical office;
- loosen the pump connections while under pressure;
 - try to clean the pump while it is running;
 - run the pump in the opposite direction to that shown in the pump casing;
 - run the pump over nominal temperature and pressure;
 - pumping liquids containing ferromagnetic particles of any size, or substances that can attack chemically or erode the inside of the pump;
 - remove guards and shelters while the pump is running;
 - act on electrical parts installed without first removing the tension, not to alter the safety devices installed, do not activate repeatedly the command buttons.

DANGER

It is incorrect any use of the pump other than that mentioned in the paragraph "Instructions for a proper use reasonably foreseeable".
Bedu disclaims any liability damages to things and people related to uses for which the pump was not specifically designed and constructed.

Also the ways in which certain situations of danger might present as a result of improper use, are prohibited.

RESIDUAL RISKS AND PROTECTION MEASURES TO BE TAKEN

Description of the residual risks that remain

Despite adopted measures incorporated in the pump, the main dangers associated with the use of the pump and the solutions identified are the followings:

Danger of sketches projection of process fluid that can be corrosive or burning, as a result of improper installation and sudden ruptures of the pump casing and hydraulic lines;

Danger of cuts to the hands due to the presence of smears on the pump casing;

Explosion of the pump is due to a formation of explosive mixture inside the pump casing as a result of an improper use.

Protection measures to be taken by the user and instructions

PROHIBITION

It is absolutely forbidden to the user to tamper with safety devices. Before using the pump check the proper couplings mechanical protection. Any tampering nullifies the warranty and liability of Bedu towards the pump users.

Only maintenance personnel can perform maintenance operation affecting safety devices.

Personal protective equipment to wear

Protection measures that have to be taken during this phase are adopting antacid and antistatic coverall, chemical-resistant glasses, gloves to protect from mechanical and chemical agents and safety shoes.

Avoid the use of accessories (necklaces, bracelets, etc.) and clothes unshackled; torn or dangling that could get entangled in parts of the structure.

OPERATIONAL LIMITS, DESCRIPTION OF HAZARDS NOT EXCLUDED FROM THE SECURITY MEASURES TAKEN

Dangers that have not been reduced/ eliminated with the security measures adopted on the pump can be reduced/eliminated if operators apply measures on management as a result of having to:



- Keep all the safety warnings of and all plaques and labels intact and replace them when necessary, periodically checking their good condition;
- Don't employ substances which may affect the physical ability or the mental faculty (alcoholic beverages, medicines, drugs, etc);

- Don't use without permission spare parts not identical to the originals or components not approved by Bedu;
- Don't perform any modification or structural intervention without the approval of Bedu;
- After shocks accidentally suffered by the pump, check the pump integrity and perform a check to Bedu;
- After a long period of pump detention check the pump integrity and functionality of stakeholders to wear. If necessary perform the replacement with identical spare parts to the originals.

CAUTION 	<p>Each of the misuse or negligence listed here causes:</p> <ul style="list-style-type: none"> - immediate cancellation of Bedu assistance. - cancellation of Bedu responsibility for damage to property, animals or people.
---	--

Safety information present on the pump

Safety warnings applied to the pump must be respected and restored in case of illegibility, and are as follow:

Warning	Description signs applied	Symbol/indication	Quantity	Notes
1.	Marking plate Bedu	As described in paragraph "PLATE"	1	1
2.	Label rotation and not run dry indication		1	2
3.	Hydro-test label		1	3
4.	Label quality control assembly		1	Internal use

INSTRUCTIONS AND PROCEDURES FOR THE TRAINING OF THE PERSONNEL AND FOR EMERGENCIES

Operators responsible for the various life stages of the pump must be:

- for assemblers: staff formed and trained on good practices for handling of goods with the use of tools and lifting equipment;
- for installers of pipes and electrical connections: qualified and trained staff to operate on electrical plants, staff with experience in hydraulic installations;
- for users: professional staff trained in the instruction for use of this pump.

In case of emergency:

- alert who is close to the situation of danger, even waving his arms;
- stop the pump by pressing the nearest emergency stop button;

Recovery mode

To return to normal operating conditions, you must delete all the causes that have generated the emergency, possibly repairing or replacing the components that caused the failure.

CAUTION

After the intervention of security devices, you must find the cause of action before continuing operations.

Fire-fighting equipment to be used:

In case of fire involving the pump, you can use water or foam liquid only after removing the voltage, or a powder type fire extinguisher with extinguishing agent. Do not use CO₂ as being launched at -79 ° C may react violently with the hot parts.

Emission / dispersion of harmful substances

The fluid in the plant might be released in the atmosphere following an intervention or the pump break.

MALFUNCTIONING, FAILURE, BREAKDOWN, ACCIDENT. MOST FREQUENT PROBLEMS: CAUSES AND REMEDIES

There aren't pump details which provide such cases of malfunctioning as to restrict or make its use dangerous. In paragraph "Most frequent drawbacks: causes and remedy" is discussed with more details in this section.

Malfunctioning and Failure

In case of failure of mechanical parts you must immediately restore the original terms of security by replacing or repairing the parts that have deficiencies.

In case of failure of the pump, proceed as follows:

- Turn the motor off;
- close the inlet and outlet valves;
- find the cause of the failure by checking the section " Most frequent drawbacks: problems, causes, remedies, residual risks".

The failure of a pumping plant can be attributed to:

- a pump failure;
- a failure or defect in the pipe;
- a failure due to an installation or a start not correctly executed;
- wrong choice of pump.

Breakdown

In the event of failure of pump alert verbally the staff present in the nearness of the damage that is verifying.

Accident

In case of accident, you must report the emergency to the plant responsible for the installation, in order to secure the plant to reach with the emergency team the place where the accident happened.

Most frequent drawbacks: problems, causes, remedies, residual risks**INSUFFICIENT FLOWS****Causes**

The head requested exceeds the pump head expected.

The pump rotates in the opposite direction.

Remedies / actions to be taken

Increase the speed rotation if possible.
Mount an impeller of greater diameter
Reduce the total head of the system if possible.
Increase the diameter of the discharge pipe.
Check that the discharge valve is fully open.
Replace the pump.
Ask your Bedu distributor.

Check the direction of rotation.
Refer to section 3.5 of this manual

Air or steam trapped in the suction.

Check the presence of air or steam trapped. Refer to section 3.4 of this manual.

The liquid contains air or steam. The liquid produces foam.

Check the presence of vortices in the suction line. Enter some in the fuel tank to prevent the formation of vortices. Install a tank of sufficient capacity in the suction line to allow gas to drag.

Insufficient inlet pressure, with the generation of cavitation and loss of efficiency.

Increase the static height at the suction. Check that the intake is not blocked or are no bottlenecks. Reduce the liquid temperature. Increase the diameter of the intake pipes. Reduce the length of inlet pipes. Open completely the inlet valve. Check the viscosity of the liquid; refer to "technical data" section of this manual, increase the temperature of the liquid if necessary.

Wear ring, wear pump casing or impeller.

Check the condition of rotating ring wear and collar. Replace if worn; refer to Chapter 10 of this manual.

The temperature of the liquid is close to boiling point

Reduce the liquid temperature.

NO FLOW

Causes

Remedies / actions

The pump is defused

Re-prime the pump. Refer to section 3.5.1 of this manual. Check for air leaks in the suction line

Suction line blocked

Ensure that there are no blind pipes, obstructed or valves closed.

The magnetic coupling decouples

Reduce the flow: partially close the discharge valve. Reduce the density of the liquid, if possible. Reduce the prevalence of the pump (check in advance with your distributor Bedu). Make sure the pump turns freely; inspect the inside in case this does not happen. Reduce the engine power installed (check in advance with your distributor Bedu). Adopt star-delta starting.

The motor stopped

Check the power of the motor. Check the status of the motor.

EXCESSIVE FLOW

Causes

Remedies / actions

The head required is lower than that provided by the pump

Reduce the speed of rotation, if possible; reduce the impeller diameter; partially close the discharge valve.

OVERHEATING OR MOTOR STOP

Excessive pumped liquid density

Reduce the flow by closing the valve outlet partially

The pump has seized or is about to seize.

Check the free rotation of the impeller. Check for internal obstructions.

The motor and pump are misaligned

Refer to section 3.8 of this manual

The motor bearings are damaged or worn.

Replace the motor bearings, investigate the causes of breakage.

Motor under dimensioned

Mount a more powerful motor (check in advance with your distributor Bedu).

Motor overload threshold set incorrectly

Check the security settings of the motor

The guard against the motor dry running (where present) has failed or has been set incorrectly.

Control flow decreases or fluid intake.

FUNCTIONING WITH NOISE DEFECTS AND/OR VIBRATIONS

Causes

Remedies / actions

Insufficient inlet pressure, consequent cavitation, insufficient lubrication of the bearings (with mechanical damages if the condition persists).

Refer to paragraphs 3.4, 3.5, 4.1, 4.2, 4.3 of this manual

STOP IMMEDIATELY THE PUMP!

Wear, erosion and immediate damage to the impeller and internal bearings.

Check inside the pump damages or obstructions.

Wear of the coupling motor-pump

Replace the coupling and proceed to the realignment of pump and motor.

Ball bearings or motor failure.

Check and replace them if necessary.

Uninsured motor or base plate.

Make sure that the motor and base plate are firmly anchored to foundations and do not produce any abnormal vibration.

Misalignment or improper anchoring of the pipes.

Check correct alignment of pipes and supports, refer to section 3.2 of this manual.

The pump was started while still rotating in the opposite direction, for a previous start.

Stop immediately the pump and drain all the liquid from the discharge line before restarting.

OVERHEATING OF EXTERNAL BEARINGS (bare shaft versions)

Lack of oil or wrong type of oil in the bearing frame.

Check the oil level: fill up or empty, and replace it if necessary. Replace the bearings.

Excessive oil temperature into the bearing frame.

Fill the bearing frame with oil ras indicated in the paragraph to restore the correct working temperatures.

PERIODIC AND EXTRAORDINARY MAINTENANCE

Proper maintenance and use are essential factors to ensure the functionality and pump lifetime.

Cleaning components and magnet

To clean all surfaces of the couplings and centering surfaces, use possibly methyl alcohol. Use paper towels instead. Do not use solvents and other corrosive liquids on magnet to avoid damaging it; any dirt can be removed from the magnets by using gummed paper. Do not hack or put pressure on the magnet during its handling, it would cause them, damages because of their fragility.

Periodic preventive maintenance

Instructions relating to maintenance activities whose implementation do not require specific skills that can then be made by users of the pump, are given. They are operations and inspections planned on issues considered important for technical, operational and security staff, determined on the basis of the knowledge gained from Bedu. If the hydraulic pump is washed with jet in pressure, prevent the entry of water into the terminal of the motor.

DANGER



Do not throw water on the pump hot components: components can explode in case of sudden cooling generating projection of metallic material and leakage of hot fluid in pressure and hazardous to health. Do not give strokes and pressures on the bearings, you would cause the formation of micro-cracks which can cause serious damages.

N.	<u>Description control / intervention: implementation rules</u>	Warnings and protective measures be taken to perform the maintenance properly and safely	Time
----	--	---	-------------

N.	<u>Description control / intervention: implementation rules</u>	Warnings and protective measures be taken to perform the maintenance properly and safely	Time
1	Ball bearing frame	Top up the oil until the middle of the eye plug	Weekly. Replace oil every 5,000 hours.
2	Internal bearings	Check the status of bushings, sleeve bearings and thrust bearings, replace them if worn	After 2500 hours, check any premature wear, then every 5,000hours or every year.
3	Wear rings	Check the status of the wear ring, consult the table of tolerances	After 2500 hours, check for premature wear, then every 5000 hours or every year.
4	Motor bearings	Unless other specifications, motor bearings are greased for life, so there is not a maintenance schedule, anyway it is recommended to check the condition of the bearings and replace them when worn	

RECOMMENDED: (TABLE OILS for ambient temperatures exceeding 15 ° c, by classification ISO VG 68)



CAUTION

BP HPL 68
 CHEVRON EP industrial oil 68
 Texaco Rando Oil HDC 68
 TOTAL Azolla 68
 Shell Tellus 68
 Mobil DTE Heavy Medium ISO 68
 STATOIL HYDRAWAY HV 68
 Esso Teresso 68 / AGIP OSO 68

In **Appendix A** is a list of periodic maintenance and inspections to be completed each time you perform such operations.

Emptying of the fluid contained in the pump

Before disassembling, you must empty the liquid from the pump according to the following steps:

- Close the valves present in the inlet and outlet pipes, and in the cooling pipe;
- Unscrew the drain plug;
- When emptied, screw the drain plug again.

If hazardous to health liquids are pumped, wear suitable personal protective equipment.

Draining the oil contained in the pump

If the pump is lubricated with oil (bare shaft versions):

- remove the oil drain plug;
- drain the oil and collected it without dispersing into the environment;
- replace the drain plug .

If there are fluids hazardous to health, wear personal protective equipment suitable before coming into contact with the liquid.

Extraordinary maintenance

The extraordinary maintenance operations concern the activities that are beyond those typically programmable and executable; they require precise technical expertise by qualified personnel, and then you should contact Bedu. Delivery is the one shown in the header of every page of this manual.

DANGER



If it becomes necessary to disassemble the pump, you must remember that the liquid should be collected and disposed in accordance to existing environmental laws. If the pump should be sent to Bedu it must be drained, and should not contain any traces of liquid pumped.

REPAIR AND PARTS REPLACEMENT

The pump must always be kept in optimum conditions of operation.

Most of the spare parts have clear and comprehensive references for their identification. It is important that the spares are replaced by similar ones so that they can be considered equivalent in quality and safety: to order original spare parts, contact Bedu referring to the model of the pump, employee number, description of the component and the quantity needed.

When you see elements with rust, cracks, etc, you must perform all replacements/repairs necessary to re-establish the conditions of the pump safe working. In any case you should always ask an opinion Bedu before any intervention.

The periodic maintenance specified in the " PERIODIC AND EXTRAORDINARY MAINTENANCE"

To allow a smooth running for a long time is necessary to make the required maintenance.

Operators should make frequent visual inspections to check that the pump is running smoothly without noise or vibration, and that the discharge pressure is holding steady, without fluctuation, at the correct figure. Overheating of the pump or motor bearings is cause for alarm. The bearing housing should not be more than 50°C above ambient temperature, nor should it exceed 80°C (too hot to touch) in any event. If the bearings overheat, shut the pump down immediately, investigate the cause, and take corrective action.

Pump disassembling

The maintenance and disassembly procedure are intended for use during standard field inspection or service. Pumps contain very strong magnets. The use of a non metallic work surface is highly recommended.

In case the pump has handled hot liquids, make sure that it cools down before disassembly. The pump could have handled dangerous or toxic liquids: it is therefore necessary to wear protection for the skin and the eyes.

The liquid must be recovered and eliminated according the existing environmental laws.

In case the pump has to be sent back to the manufacturer to be reconditioned, in case it pumped aggressive or toxic liquids, the same has to be thoroughly drained and cleaned by the customer.

Bring in mind the instructions described in Chapter 9 "Periodic preventive maintenance ", disassemble as follows:

- 1) Remove bolts connecting pump and motor to foundation or base plate.
- 2) Remove hex bolts connecting pump to motor.

- 3) Separate the pump from the motor and pull the driver away from the pump.

⚠ WARNING ⚠ MAGNETIC

Bedu units contain extremely strong magnets. The use of non magnetic tools and work surface is highly recommended. Strong magnetic attraction when disassembling / assembling drive end to liquid end.

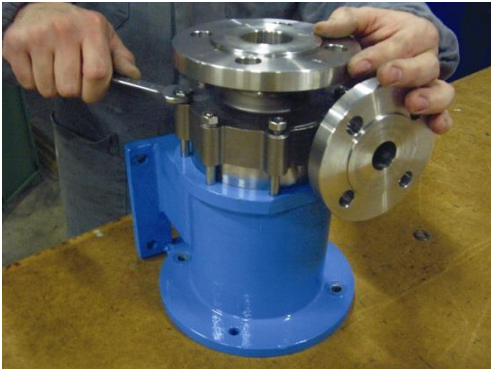

⚠ CAUTION

The shop area must be clean and free of any ferrous particles.

- 4) Remove pump casing hex nut..

- 5) Pull out the pump casing.



- 6) Pull out the internal assembly from the bracket.

- 7) Remove shaft hex nut and pull out the impeller.



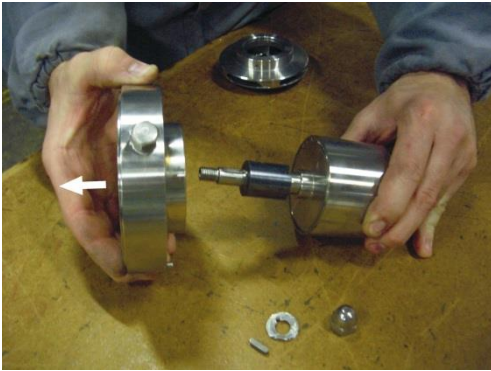

⚠ MAGNETIC

Reminder: Keep all metal tools away from magnetic field of the inner magnet.

8) Remove the shaft support.

9) Remove the internal magnet hex nut.



10) Pull out the internal magnet from the shaft.

11) Pull out the key from the shaft.



12) Pull out the sleeve bushing from the shaft.

⚠ MAGNETIC

Reminder: Keep all metal tools away from magnetic field of the inner magnet.



13) Remove the screw from external magnet hub.

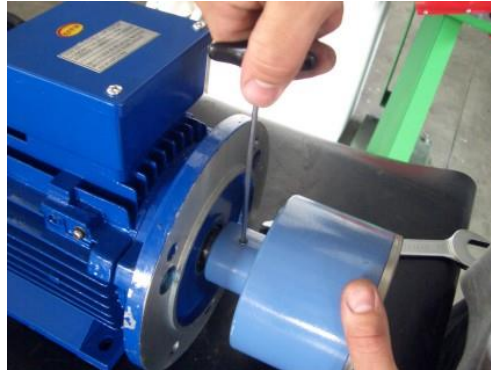

14) Using an extractor pull-out the external magnet from motor shaft.

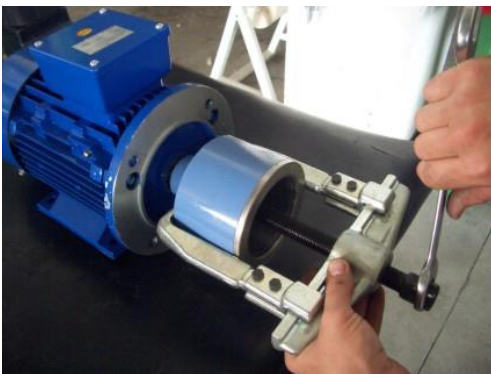

Now you can replace all worn or damaged parts.

Pump reassembling

To reassemble the pump, follow the instructions in reverse order.

Thoroughly clean every component before assembly, make sure all parts are free of dirt, metal particles, etc.

CAUTION



During the first assembly, or reassembly of the pump, it is recommended to apply the low strength thread locker (AREXONS 52A22 - LOCTITE 222 or equivalent) on the locking nut of the external magnet to prevent unscrewing problems.

DECOMMISSIONING, DISMANTLING AND DISPOSAL OF MATERIALS

Decommissioning

For an eventual long time decommissioning, it is advisable to apply some simple precautions to preserve correctly the pump.

Make the pump run with clean water (or other suitable solvent compatible with the materials of the pump) for several minutes, in order to avoid the risk of liquid precipitation or deposits. Disconnect from the electric power / liquid supply and place it in a protected site.

During the commissioning after a long period of stocking, carefully follow all recommendations for commissioning described at beginning of this manual

APPENDIX B – Startup check list

	PUMP SERIES CM MAG-M	
	- Do not destroying – do not modify -	Rev. N°00 Date 21/02/2013
	STARTUP CHECK LIST	This document consists of 2 pages

Nr.	Description of activity	YES / ✓	NO / x
*UPON ARRIVING CHECKS:			
1	Check Pump Name Plate , Motor Name plate to tally with PO and Data Sheet		
2	Any Cracks or damages to Pump or motor during shipment or handling		
3	Check accessories if ordered to tally with PO		
4	Are Installation, Operation and Maintenance Manuals for Pump, Motor and Coupling supplied?		
5	Have you received the Pump Curve, GA Drawing, Pump Data Sheet, Motor Data Sheet and Wiring Diagram?		
6	Have you read through and understand the IOM manuals?		
*INSTALLATION CHECKS:			
1	Has the Pump's baseplate being properly level and firmly secured?		
2	Has the Pump and motor coupling being secured and aligned?		
3	Are Suction and Discharge Pipe line with Flexible Joints being Supported and Secured?		
4	Any undue Pipe loading onto Pump inlet/Outlet Nozzle due to Mis-alignment		
5	Is Suction Strainer being installed to protect the Pump?		
6	Are Suction and Discharge Pressure Gauge being installed before Pump's Inlet and Outlet?		
7	Is there any Check Valve being installed at Pump's discharge Outlet?		
8	Has the Power supplied for Electrical Motor being connected by qualified electrical personnel?		

9	Have the Pump Bearings been filled with recommended Lubricating Oil and to the stated level (For Long Coupled Pump)?		
10	Have the motor Bearings been greased if required?		
* PRE START-UP			
1	For High /Low Temperature Pumping application , has the pump been warmed up to required Temperature?		
2	Can the Pump shaft turns freely by hand?		
3	Fully Open the Suction Valve.		
4	Partially Open the Discharge.		
5	Ensure Suction line is Filled and the Pump been Primed of entrained Air.		
6	Jog Start the motor, Verify that the direction of rotation is correct.		
* AFTER START-UP			
1	Start the pump set and be sure that the discharge pressure is building up(stop the pump if discharge pressure is not building up in short time and check the possible causes		
2	Throttle or Set Discharge Valve to designed Duty Point. (Pressure and Flow Rate)		
3	Reading of Suction Pressure () Discharge Pressure () and Flow Rate ().		
4	Are the Suction and Discharge Pressure Gauge Stable?		
5	Check Pump bearing and motor bearing temperatures are stabilized below 82 deg C.		
6	Amperage reading does not exceed nameplate full load amps plus S.F.		
7	Checked no abnormal temperature and leakage.		
8	Checked no abnormal pump vibration and noise.		

9	Under Normal Condition, continuously run the pump under observation for one or two hours.		
---	---	--	--

COMMENTS/REMARKS:

INSTALLATION REFERENCE:

PROJECT:		CONTACT:	
CONTRACTOR:			
ADDRESS:			
PHONE NO:		FAX:	
PUMP MODEL NO:		SERIAL NR:	
MOTOR TYPE:		IMPELLER DIAMETER:	
START-UP BY:		FOLLOW UP REQD:	
DATE:		SIGNATURE:	



EC - Declaration of Conformity

Manufacturer Details

Tradename

Bedu Pompen BV

Address

Poort van Midden Gelderland Rood 10, 6666 LT, Heteren, Netherlands

Product Details

Product Name

Centrifugal pumps

Model (+series) Name

CMMAG-Mseries

Applicable Standards Details

Directives

2006/42/EC (Machinery Directive)
2014/35/EU (Low Voltage Directive)
2014/30/EU (Electromagnetic compatibility)

Standards

EN-ISO 12100:2010
EN-IEC 60204-1:2006
EN 809+A1/C1

Additional information

No further details.

Declaration

We hereby declare under our sole responsibility that the product(s) mentioned above to which this declaration relates complies with the above mentioned standards and Directives.

Name Director(s):

Issued Date:

01/10 2014

BEDU Pompen BV

Poort van Midden Gelderland Rood 10
6666 LT Heteren

Tel : +31 (0)88 - 4802 900

Fax : +31 (0)88 - 4802 901

E-mail : info@bedu.nl

Website : www.bedu.eu

Marco Breunissen

Ron Bijen

Signature of representative(s)



BEDU
≡ POMPEN ≡

made for your process

- Deskundig advies
- Een klantgerichte organisatie die zich aanpast aan de eisen en wensen van uw organisatie
- Innovatieve en maatwerkoplossingen
- Storingsdienst 24 uur per dag, 7 dagen in de week
- Technische dienst met uitgebreide testfaciliteiten, werkend vanuit onze eigen werkplaats of bij u op locatie
- Een snelle en passende oplossing voor al uw vraagstukken
- Breed assortiment vloeistofpompen
- Reparatie, onderhoud en revisie

BEDU POMPEN B.V.
Poort van Midden Gelderland Rood 10
6666 LT HETEREN
Nederland
Telefoon +31 (0)88 4802 900
Fax +31 (0)88 4802 901
E-mail info@bedu.nl

WWW.BEDU.NL

BEDU BELGIUM B.V.B.A.
Industriepark-West 75 bus 24
9100 SINT-NIKLAAS
België
Telefoon +32 (0)3 80 87 980
Fax +32 (0)3 80 87 981
E-mail info@bedu.be

WWW.BEDU.BE

