



Construction

Close-coupled self-priming shallow well jet pumps with built-in ejector.

NG: version with pump casing and lantern bracket in cast iron.

B-NG: version with pump casing and lantern bracket in bronze (the pumps are supplied fully painted).

Applications

For drawing water out of a well.

As pressure boosting pump for central water systems with low pressure (follow local specifications if increasing network pressure).

For clean liquids or slightly dirty surface water.

For garden use.

For washing with a jet of water.

Operating conditions

Liquid temperature up to 40 °C.

Ambient temperature up to 40 °C.

Maximum permissible working pressure up to 10 bar.

Continuous duty.

Motor

2-pole induction motor, 50 Hz ($n \approx 2900$ rpm).

NG: three-phase 230/400 V \pm 10%.

NGM: single-phase 230 V \pm 10%, with thermal protector. Capacitor inside the terminal box.

Insulation class F.

Protection IP 54.

Classification scheme IE3 for three-phase motors from 0,75 kW.

Constructed in accordance with: EN 60034-1; EN 60034-30-1.

EN 60335-1, EN 60335-2-41.

Special features on request

- Other voltages. - Frequency 60 Hz (as per 60 Hz data sheet).

- Protection IP 55.

- Special mechanical seal

Materials

Components	NG	B-NG
Pump casing Cover with lantern bracket Diffuser plate	Cast iron GJL 200 EN 1561	Bronze G-Cu Sn 10 EN 1982
Impeller	Brass P- Cu Zn 40 Pb 2 UNI 5705	
Shaft	Cr steel 1.4104 EN 10088 (AISI 430) for NG 3-4 Cr-Ni steel 1.4305 EN 10088 (AISI 303) for NG 5-6-7	Cr-Ni-Mo steel 1.4401 EN 10088 AISI 316
Ejector casing NG 32	Cast iron GJL 200 EN 1561	-
Diffuser	PPO-GF20 (Noryl)	
Nozzle	PPO-GF20 (Noryl)	
Mechanical seal	Carbon - Ceramic - NBR	

Characteristic curves for suction lift $H_s = 1$ m $n \approx 2900$ rpm

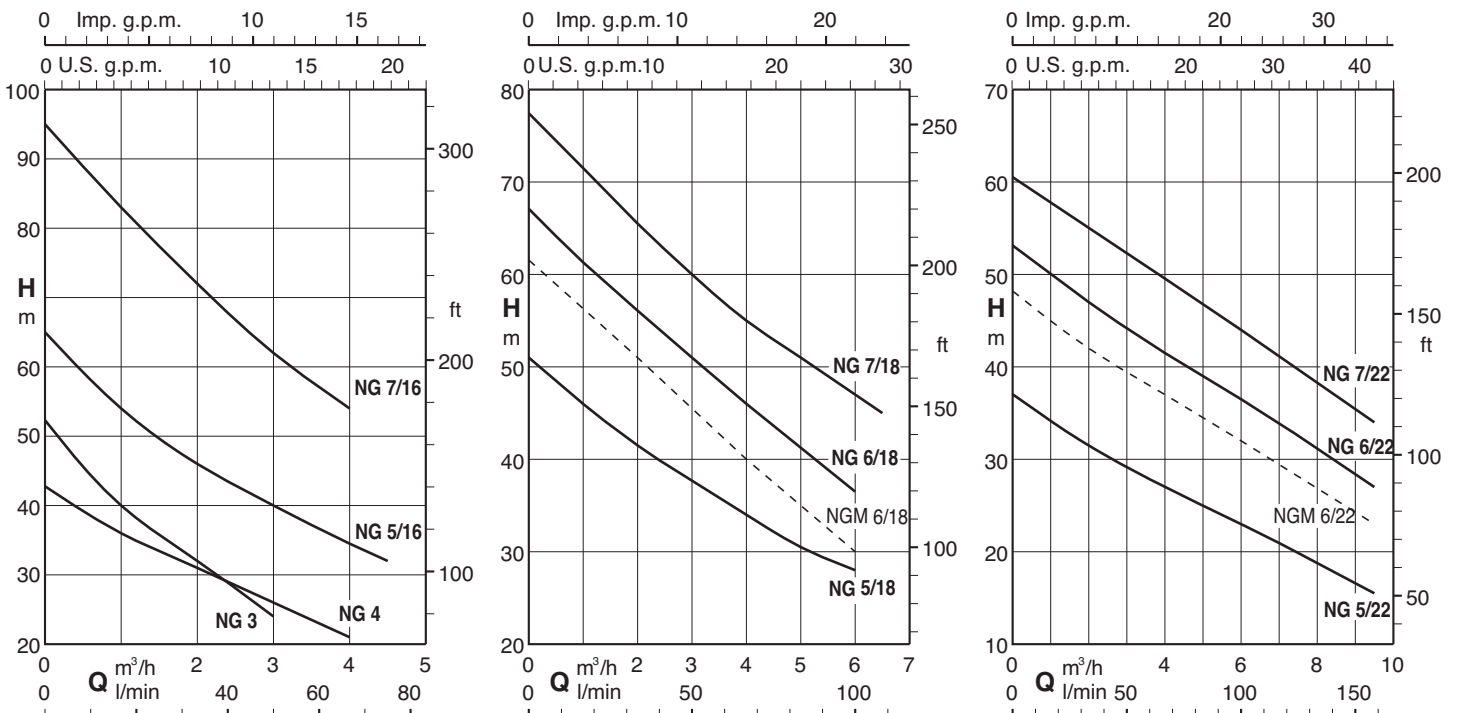

Performance for suction lift Hs = 1 m n ≈ 2900 rpm

3 ~	230V 400V		1 ~	230V		P ₂		Q m ³ /h l/min	H m																	
	A	A		A	kW	kW	HP		0,25	0,5	1	1,5	2	2,5	3	3,5	4	4,5	5	5,5	6	6,5	7	8	9	9,5
B- NG 3/A	3	1,7	B- NGM 3/A	4,5	0,9	0,55	0,75	49	45,5	40	36	32	28	24												
B- NG 4/B	3,7	2,2	B- NGM 4/A	5,7	1	0,75	1	41	39	36	33	31	29	26	24	21										
B- NG 5/16/A	4,7	2,7	B- NGM 5/16E	7,4	1,64	1,1	1,5		59	54	50	46	43	40	37	34,5	32									
B- NG 5/18/A	4,7	2,7	B- NGM 5/18E	7,4	1,68	1,1	1,5		48,5	46	43,5	41,5	39,5	38	35,5	34	32	30,5	29	28						
B- NG 5/22/A	4,7	2,7	B- NGM 5/22E	7,4	1,55	1,1	1,5		35,5	34,5	33	31,5	30,5	29,5	28	27	26	25	23,5	23	21,5	20,5	18,5	16,5	15,5	
B- NG 6/18/A	7,5	4,3				1,5	2		64,5	62	59	56	54	51	48,5	46	43,5	41,5	39	36,5						
			B- NGM 6/18E	9,2	2	1,5	2		59	57	54	51	48	45	43	40	37,5	35	33	30						
B- NG 6/22/A	7,5	4,3				1,5	2		51,5	50	48,5	47	46	44,5	43	41,5	40	39	37,5	36,5	35	33,5	31	28,5	27	
			B- NGM 6/22E	9,2	2	1,5	2		47	45	43,5	42	41	40	38	37	36	35	33	32	31	30	27	24	23	
B- NG 7/16/B	9,15	5,3				2,2	3		89	83	77	72	67	62	58	54										
B- NG 7/18/B	9,15	5,3				2,2	3		74,5	71,5	68,5	65,5	63	60	57,5	55	53	51	49	47	45					
B- NG 7/22/B	9,15	5,3				2,2	3		59	57,5	56,5	55	54	52,5	51	50	48,5	47	45,5	44	42,5	41,5	38	35	34	

P1 Max. power input.

P2 Rated motor power output.

B-NG, B-NGM = Bronze construction.

Tolerances according to UNI EN ISO 9906:2012

Characteristic curves $n \approx 2900$ rpm

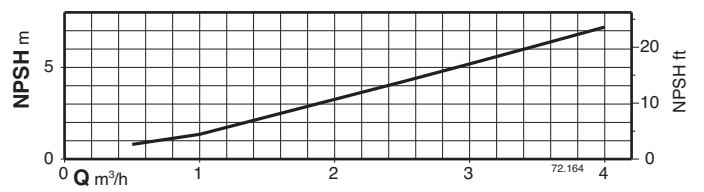
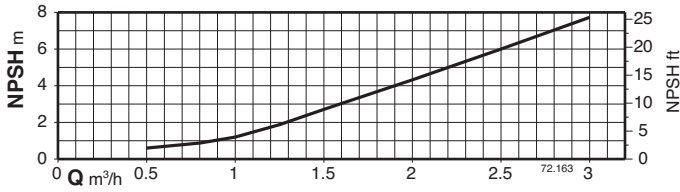
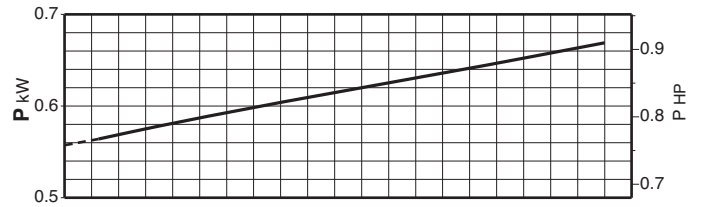
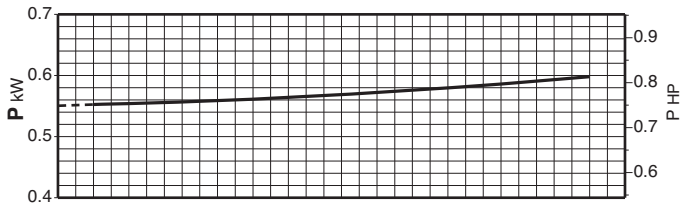
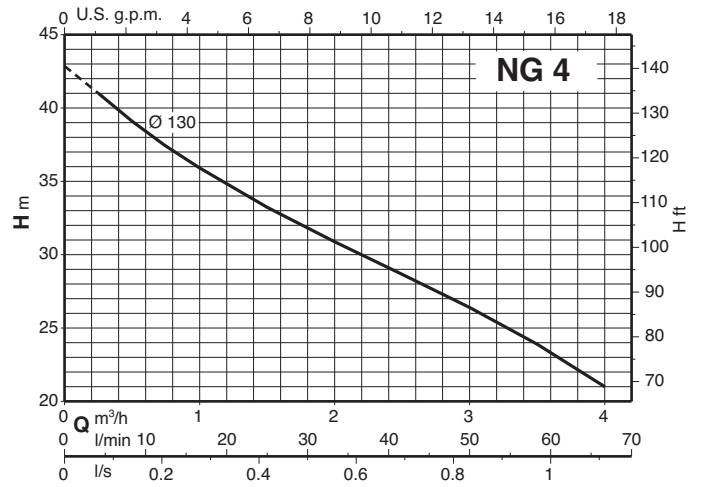
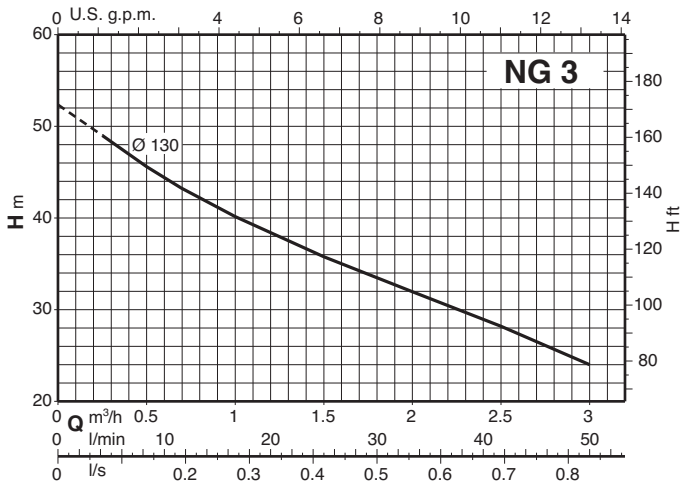

Characteristic curves $n \approx 2900$ rpm

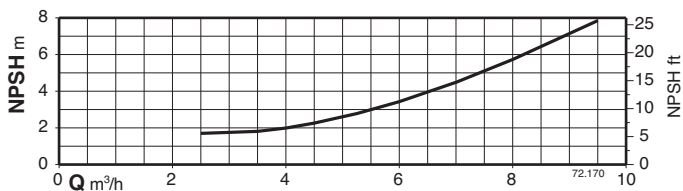
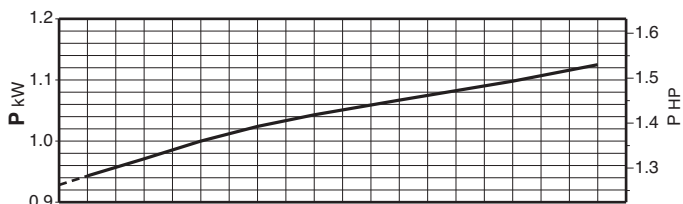
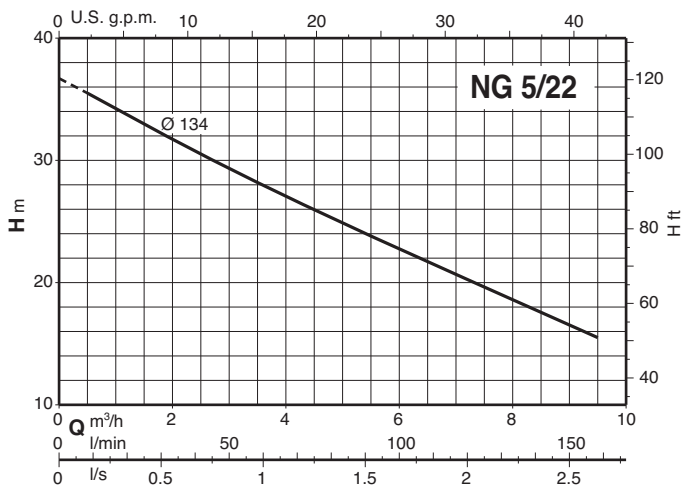
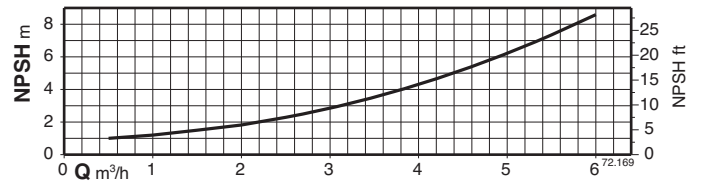
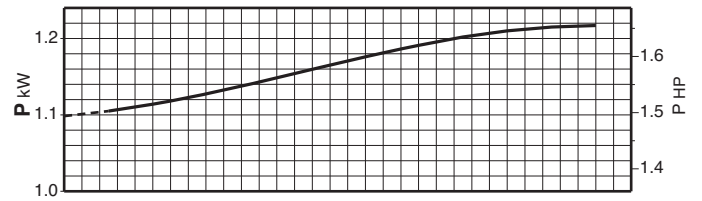
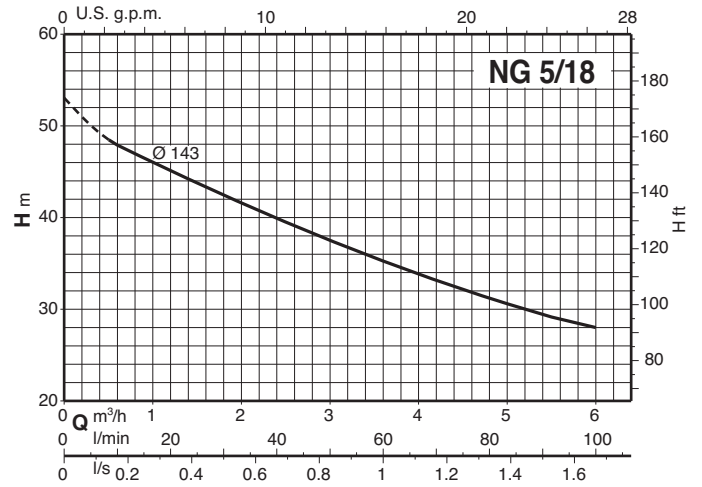
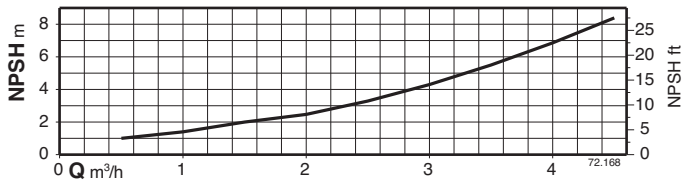
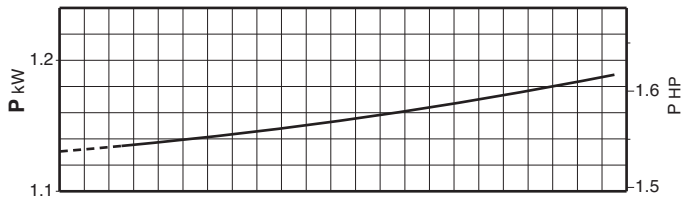
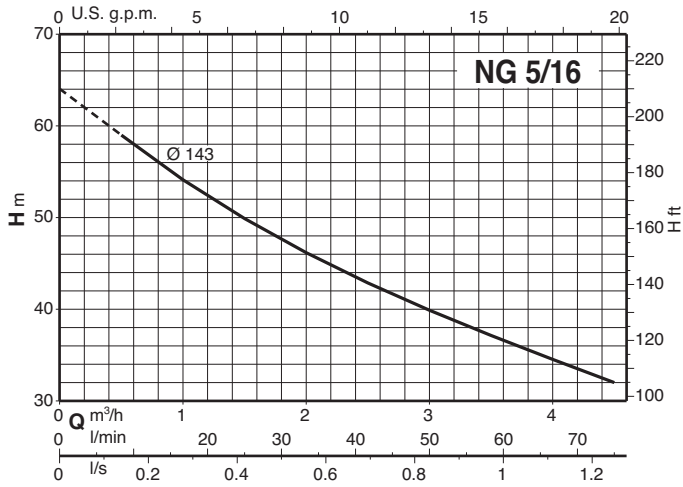

Characteristic curves $n \approx 2900$ rpm

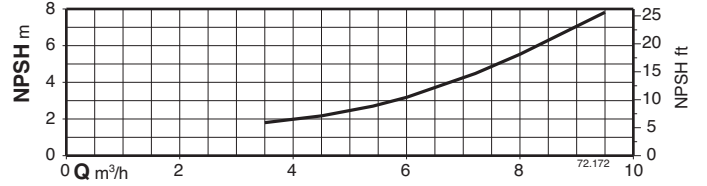
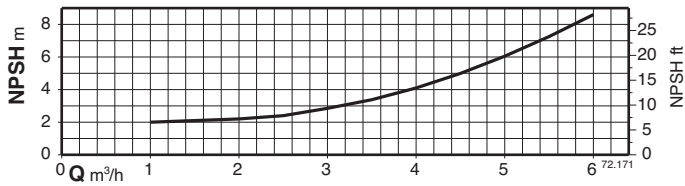
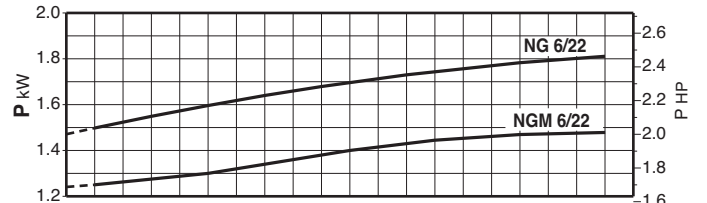
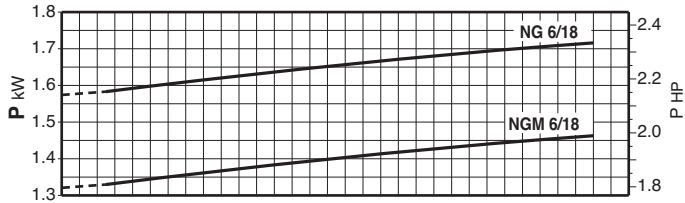
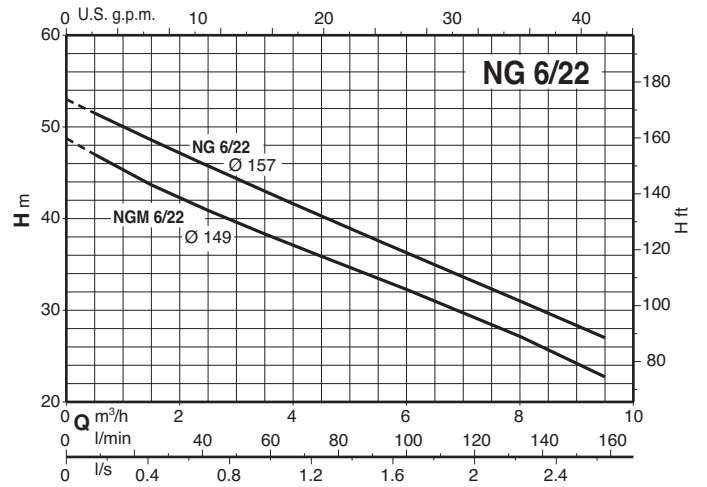
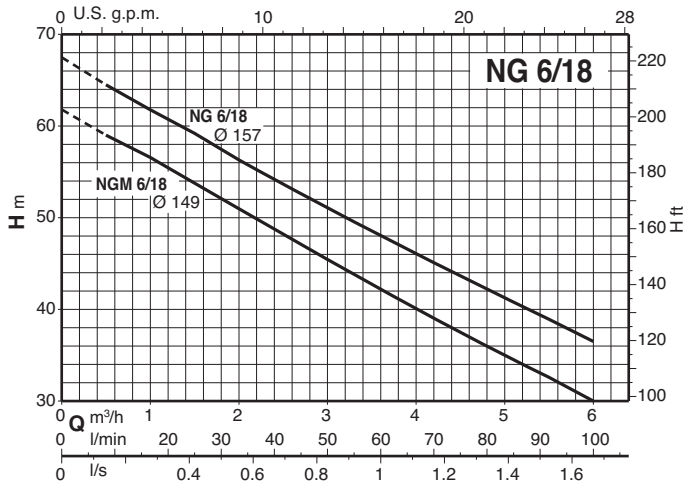

Characteristic curves $n \approx 2900$ rpm

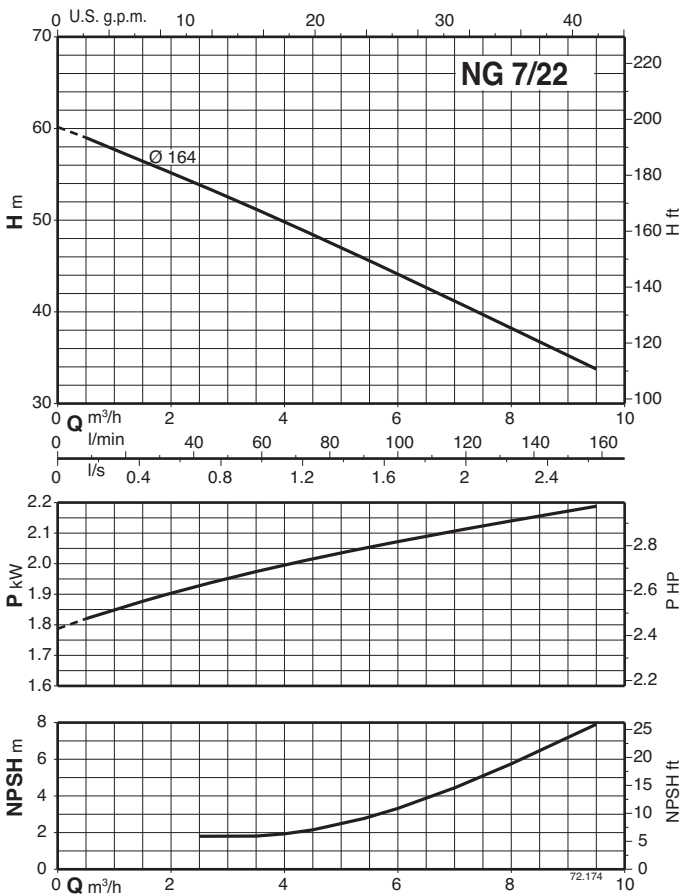
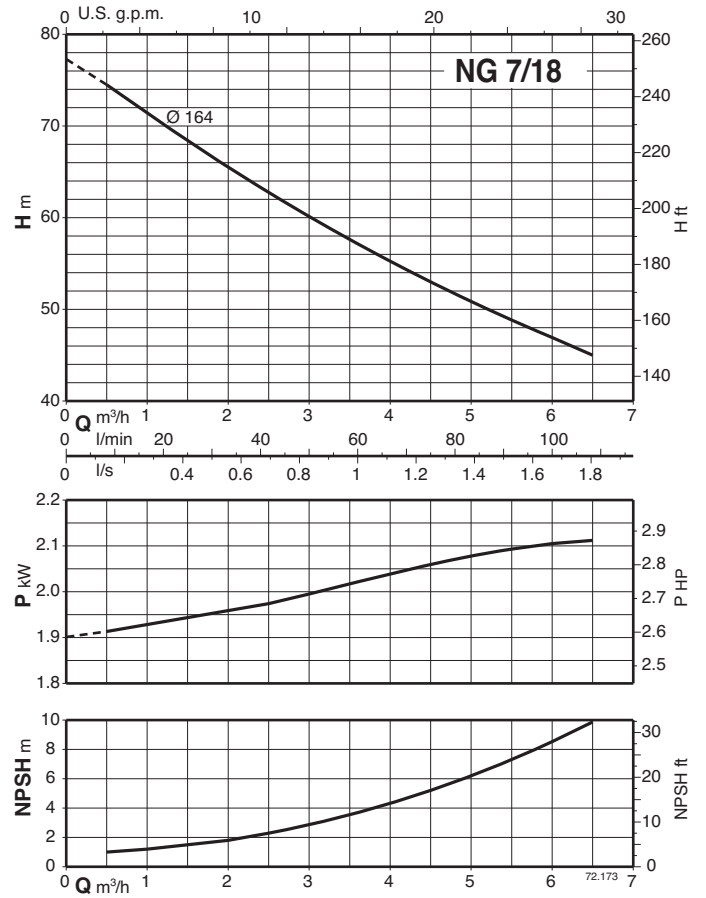
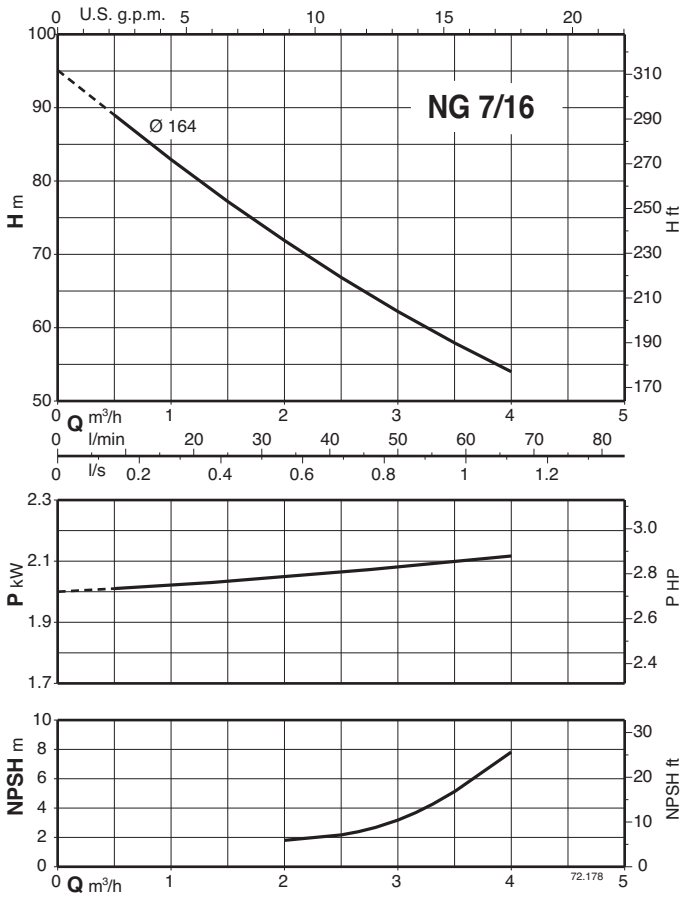

Dimensions and weights

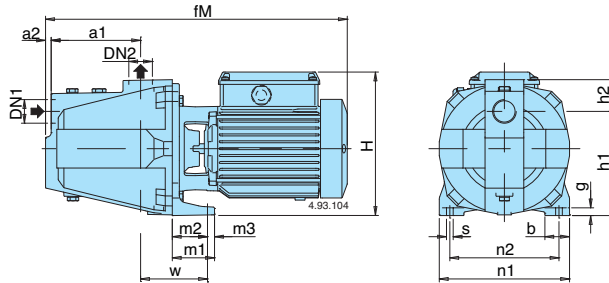

TYPE	DN ₁	DN ₂	mm															kg		
			ISO 228		a1	a2	fM	h1	h2	H	m1	m2	m3	n1	n2	b	s	w	g	NG
NG 3/A NG 4/B	B-NG 3/A B-NG 4/B	G 1 G 1	G 1 G 1	127	8	430	150	43	207	60	52	8	185	155	35	9,5	100	11	18,4 20,0	20,8 22,3
NG 5/A NG 6/A NG 7/B	B-NG 5E B-NG 6E B-NG 7/A	G 1 1/2 G 1	G 1 G 1	160	10	560 560 600	165	57	240	60	50	10	215	175	40	11,5	115	11	29,2 30,8 31,3	31,6 32,9 33,4

Installation examples

Positive suction head operation

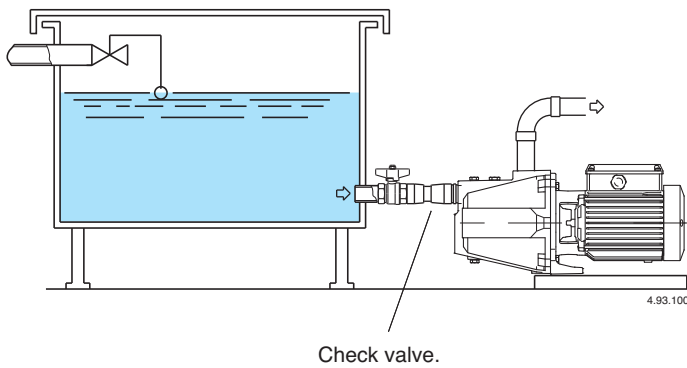

Suction lift operation

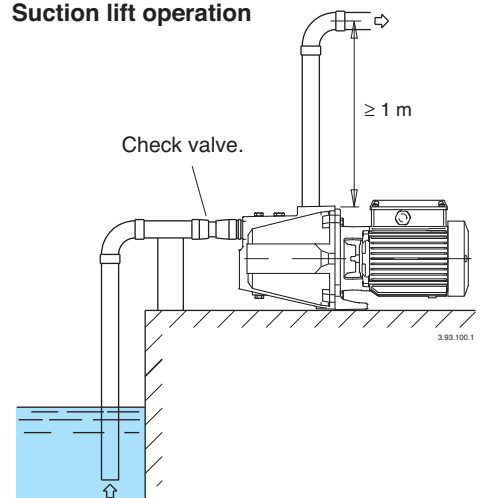

Features

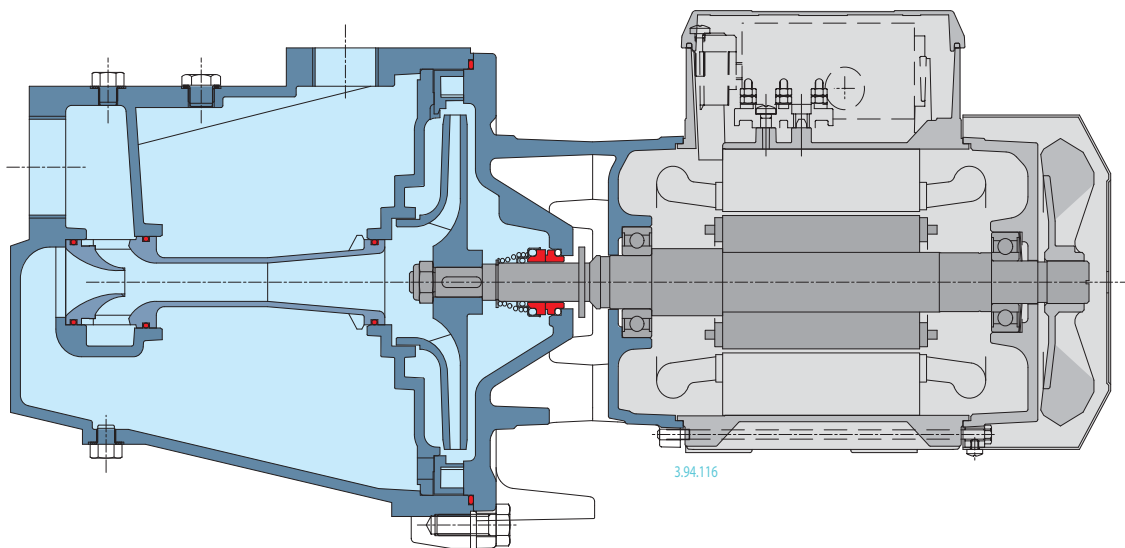
**Robust**

The mechanical structure of the hydraulic parts in contact with the pumped liquid are dimensioned to guarantee the maximum resistance to mechanical stress.

Self priming

The hydraulic design allows the pump to self prime even with the high suction lifts or with long suction pipe runs above the water level.

Flexible

The option to choose between cast iron and bronze materials for the hydraulic parts in contact with the pumped liquid allows NG series pumps to be selected for use with different types of liquids.